



G5238FT Digital QR Primary-Side Power Switch

Digital Power™

1.0 General Description

The G5238FT is a high performance AC/DC power supply controller which uses digital control technology to build peak current mode PWM flyback power supplies. The device operates in quasi-resonant mode to provide high efficiency along with a number of key built-in protection features while minimizing the external component count, simplifying EMI design and lowering the total bill of material cost. The G5238FT removes the need for secondary feedback circuit while achieving excellent line and load regulation. It also eliminates the need for loop compensation components while maintaining stability over all operating conditions. Pulse-by-pulse waveform analysis allows for a loop response that is much faster than traditional solutions, resulting in improved dynamic load response for both one-time and repetitive load transients. GlobalSemi's innovative proprietary technology ensures that power supplies built with the G5238FT can achieve both highest average active efficiency and have fast dynamic load response in a compact form factor in typical applications.

Features

- ◆ Built-in 650V Power Mosfet
- ◆ No-load power consumption < 75 mW at 230 VAC along with fast dynamic load response
- ◆ Tight constant-voltage and constant current regulation across line and load range
- ◆ Primary-side feedback eliminates opto-isolators and simplifies design
- ◆ Proprietary optimized 90 kHz maximum PWM switching frequency with quasi-resonant operation achieves best size, efficiency and common mode noise
- ◆ Adaptive Multi-mode PWM/PFM control improves efficiency
- ◆ No external loop compensation components required
- ◆ User-configurable 5-level cable drop
- ◆ Complies with EPA 2.0 energy-efficiency specifications with ample margin
- ◆ Built-in: output SCP, output OVP, OCP, current-sense-resistor fault protection .
- ◆ No audible noise over entire operating range

Applications

- Compact AC/DC adapter/chargers for media tablets and smart phones
- AC/DC adapters for consumer electronics

TYPICAL Application

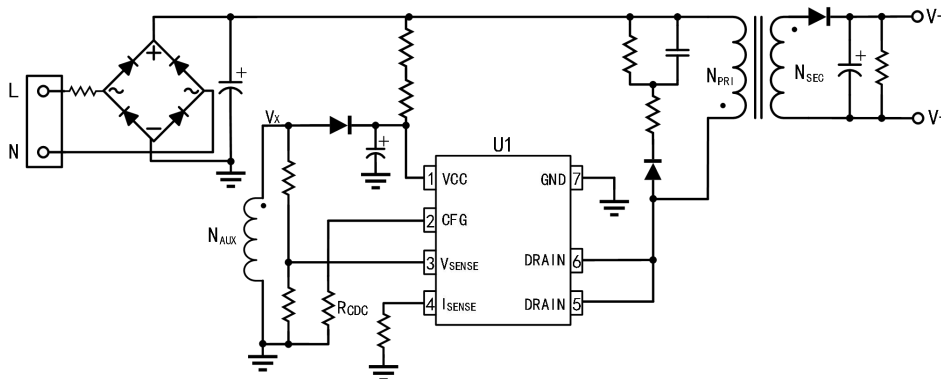

G5238FT
Digital QR Primary-Side Power Switch

2.0 Products Information

2.1 Pin configuration

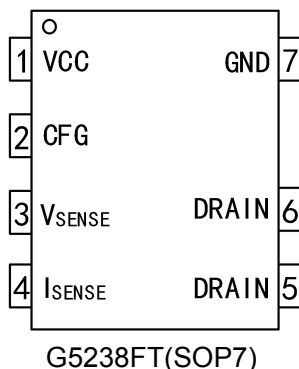

Name	Pin	I/O	Description
VCC	1	Power Input	Power supply for the controller during normal operation. The controller will start up when VCC reaches 14.0 V (typical) and will shut down when the VCC voltage drops below 6.5 V (typical). A decoupling capacitor of 0.1 μ F or so should be connected between the VCC pin and GND.
CFG	2	Analog Input	Used to configure external cable drop compensation (CDC) at the beginning of start-up and provide accurate over-voltage protection during normal operation by sensing output voltage via auxiliary winding.
V _{SENSE}	3	Analog Input	Sense signal input from auxiliary winding. This provides the secondary voltage feedback used for output regulation..
I _{SENSE}	4	Analog Input	Primary current sense. Used for cycle-by-cycle peak current control and limit.
DRAIN	5/6	Output	HV MOSFET Drain Pin. The Drain pin is connected to the primary lead of the transformer
GND	7	Ground	Ground.

